

GENERAL CHARACTERISTICS

Nominal Overall Diameter	306	mm
Nominal Voice Coil Diameter	25	mm
Magnet Weight	270	g
Flux Density	0.95	T

THIELE-SMALL PARAMETERS

Voice Coil DC Resistance	R_E	6.80	Ω
Resonance Frequency	f_s	78.0	Hz
Mechanical Q Factor	Q_{MS}	7.51	
Electrical Q Factor	Q_{ES}	1.10	
Total Q Factor	Q_{TS}	0.96	
Mechanical Moving Mass	M_{MS}	29.8	g
Mechanical Compliance	C_{MS}	141.0	μm/N
Force Factor	$B \times l$	9.50	Wb/m
Equivalent Acoustic Volume	V_{AS}	47.8	lt.
Maximum Linear Displacement ...	X_{MAX}	1.50	mm
Reference Efficiency	η_0	1.96	%
Diaphragm Area	S_D	490.8	cm ²
Losses Electrical Resistance	R_{ES}	47.0	Ω
Voice Coil Inductance @ 1kHz	L_E	1.15	mH

CONSTRUCTIVE CHARACTERISTICS

Magnet	Ferrite
Voice Coil Winding	Copper
Voice Coil Former	Epotex
Cone	Paper
Surround	Integrated Paper
Dust Dome	Non Treated Cloth
Basket	Pressed Sheet Steel

ELECTRICAL CHARACTERISTICS

Nominal Impedance	8	Ω
Rated Power (DIN 45573 - IEC 268.5)	35	W
Musical Power (DIN 45500)	70	W
Sensitivity @ 1 W, 1 m	95.6	dB

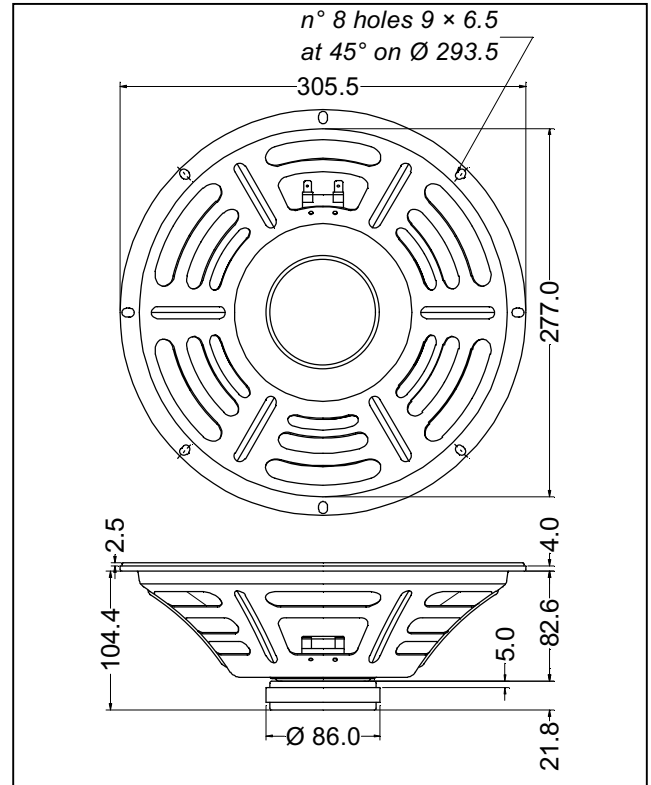

Frequency Response on IEC Baffle (DIN 45575) @ 1 W, 1 m - Impedance

